

Data Sheet



Article number: 03441260

Description: Fluro Rod end GE 260EC-2RS

Measures

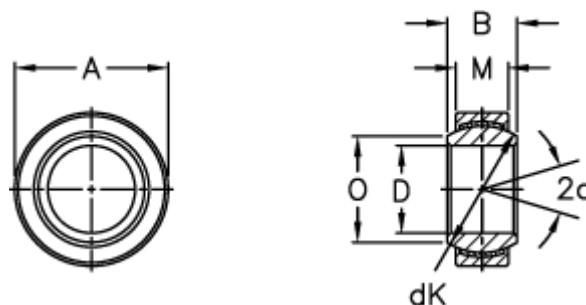

A = 370 0 -0,040

B = 150

D = 260 0 -0,035

dK = 325

Dynamic load C (kN) = 5700

M = 110

O = 288.3

Static load C0 (kN) = 11400

Tilt angle = 7

Weight = 50000